

IEC Appliance Inlet C8, Snap-in Mounting, Front Side, Solder Terminal



Snap-in version



See below:

[Approvals and Compliances](#)

Description

- Panel Mount :
Snap-in version , from front side
- 1 Function
- Appliance Inlet , Pin temperature 70 °C , Protection class II
- Solder terminals

Characteristics

- Contact pins rolled

References

We recommend for new applications the type [2570](#)

Weblinks

[pdf datasheet](#), [html-datasheet](#), [General Product Information](#), [Distributor-Stock-Check](#), [Accessories](#), [Detailed request for product](#)

Technical Data

Ratings IEC	2.5 A / 250 VAC; 50 Hz
Ratings UL/CSA	2.5 A / 250 VAC; 60 Hz
Dielectric Strength	> 2 kVAC between L-N (1 min/50 Hz)
Allowable Operation Temperature	-25 °C to 70 °C
IP-Protection	from front side IP 40 acc. to IEC 60529
Insulation cover	Suitable for appliances with protection class II acc. to IEC 61140
Terminal	Solder terminals
Panel Thickness S	Snap-in from 0.8 - 1.6 mm
Material: Housing	Thermoplastic, black, UL 94V-0

appliance inlet/-outlet	C8 acc. to IEC 60320-1, UL 498, CSA C22.2 no. 42 (for cold conditions) pin-temperature 70 °C, 2.5 A, Protection Class II
-------------------------	--

Approvals and Compliances

Detailed information on product approvals, code requirements, usage instructions and detailed test conditions can be looked up in [Details about Approvals](#)

Approvals



The approval mark is used by the testing authorities to certify compliance with the safety requirements placed on electronic products.

Approval Reference Type: 0721

Approval Logo	Certificates	Certification Body	Description
	SGSFimko Approvals	SGSFimko	Certificate Number: 2016028
	UL Approvals	UL	UL File Number: E96454
	CSA Approvals	CSA	CSA Certification Record: 73165
	CQC Approvals	CQC	CCC Certificate Number: 2011010204483971

Product standards

Product standards that are referenced

Organization	Design	Standard	Description
	Designed according to	IEC 60320-1	Appliance couplers for household and similar general purposes
	Designed according to	UL 498	Standard for Attachment Plugs and Receptacles
	Designed according to	CSA C22.2 no. 42	General Use Receptacles, Attachment Plugs, and Similar Wiring Devices





Application standards

Application standards where the product can be used

Organization	Design	Standard	Description
	Designed for applications acc.	IEC/UL 60950	IEC 60950-1 includes the basic requirements for the safety of information technology equipment.

Compliances

The product complies with following Guide Lines

Identification	Details	Initiator	Description
	CE declaration of conformity	SCHURTER AG	The CE marking declares that the product complies with the applicable requirements laid down in the harmonisation of Community legislation on its affixing in accordance with EU Regulation 765/2008.
	RoHS	SCHURTER AG	EU Directive RoHS 2011/65/EU
	China RoHS	SCHURTER AG	The law SJ / T 11363-2006 (China RoHS) has been in force since 1 March 2007. It is similar to the EU directive RoHS.
	REACH	SCHURTER AG	On 1 June 2007, Regulation (EC) No 1907/2006 on the Registration, Evaluation, Authorization and Restriction of Chemicals 1 (abbreviated as "REACH") entered into force.

Dimensions [mm]

0721-PS

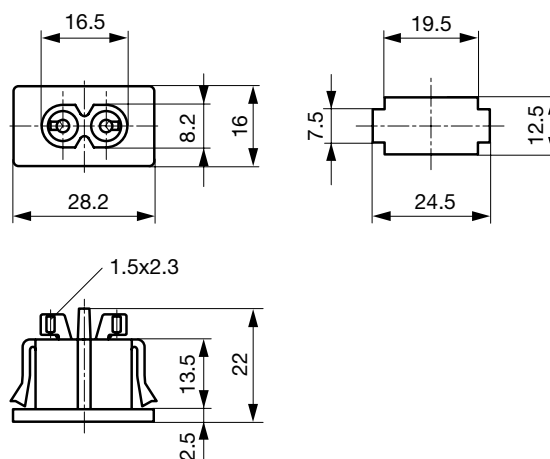

Solder terminals for wires

All Variants

Type	Panel mounting	Panel Thickness s [mm]	Terminal	Order Number
0721-PS	Snap-in	0.8 - 1.6	Solder terminals	4300.0098

Most Popular.

Availability for all products can be searched real-time: <https://www.schurter.com/en/Stock-Check/Stock-Check-SCHURTER>

Packaging unit 100 Pcs

Mating Outlets/Connectors

Category / Description

Power Cord Overview complete



Cord Sets 2.5 A, IEC Connector, Black, 2.0 m, H03VVH2-F 2x0,75mm2, Connector IEC C7, 001500 mm, H03VVH2-F2G0.75, black	6013.0474
Cord Sets 2.5 A, IEC Connector, Black, 4.0 m, H03VVH2-F 2x0,75mm2, Connector IEC C7, 001500 mm, H05VVH2-F2G0.75, black	6013.0478
Kabelverbindung/2.5, IEC Connector, Black, 2.0 m, H03VVH2-F 2x0,75mm2, Connector IEC C7, 001500 mm, H03VVH2-F2G0.75, black	6051.0015

[Power Cord further types to 0721-PS](#)

Power Supply Cord Overview complete



Cord Sets 2.5 A, North America, Black, 2.0 m, SVT 2x18AWG, Connector IEC C7, 002500 mm, NISPT-2, black	6010.5274
Cord Sets 2.5 A, North America, Black, 4.0 m, SVT 2x18AWG, Connector IEC C7, 002500 mm, NISPT-2, black	6010.5278
Kabelverbindung/2.5, North America, Black, 2.5 SVT 2x18AWG, IEC C7, 002500 mm, SVT 2x18 AWG, black	6051.0018

[Power Supply Cord further types to 0721-PS](#)

Mouser Electronics

Authorized Distributor

Click to View Pricing, Inventory, Delivery & Lifecycle Information:

[Schurter:](#)

[4300.0098](#)